

# Eclisse **CIRCULAR** double



## Double Curved Sliding Pocket Door System

Continue the curve and create architecturally sophisticated designs of movement and shape.

Make a spectacular entrance or exit with this stunning feature.

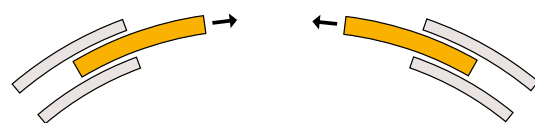

## Available Accessories



### Door Furniture

Simple Flush Pulls and Bathroom furniture, see page 43

## Real Wood Veneers, paint/stain ready

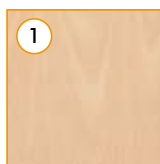

1

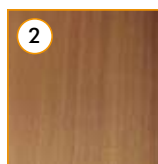

2

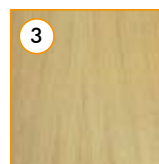

3

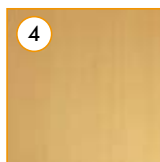

4

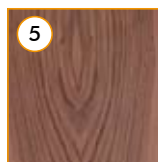

5

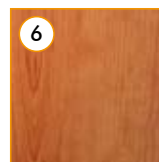

6

- 1) Cherry walnut
- 2) Mahogany
- 3) Oak
- 4) Beech
- 5) Walnut
- 6) Cherry

# FRAMES FOR DOUBLE CURVED DOORS

finished wall thickness **125** mm

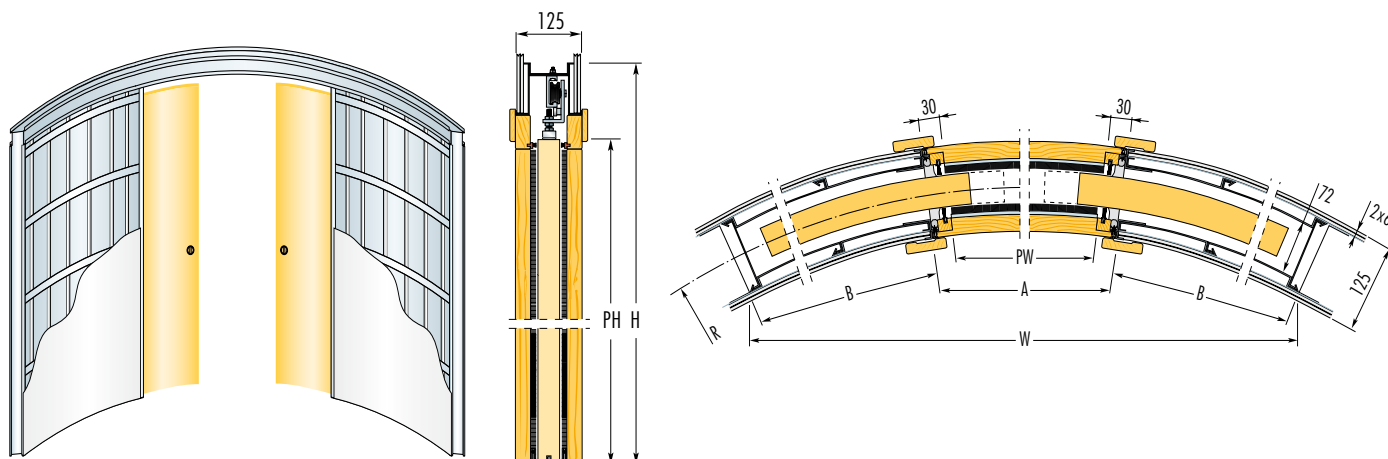

FRAMES FOR DOUBLE CURVED DOORS					
Radius R	Max. Passage Size PW x PH	Overall Dimension W x H	A	B	Finished Wall
1000	1200 x 2000/2100	1870 x 2158/2258	1260	695	125
	1400 x 2000/2100	1840 x 2158/2258	1460	820	125
1200	1200 x 2000/2100	2115 x 2158/2258	1260	665	125
	1400 x 2000/2100	2265 x 2158/2258	1460	800	125
	1600 x 2000/2100	2295 x 2158/2258	1660	930	125
	1800 x 2000/2100	2180 x 2158/2258	1860	1055	125
1300	1200 x 2000/2100	2180 x 2158/2258	1260	670	125
	1400 x 2000/2100	2345 x 2158/2258	1460	760	125
	1600 x 2000/2100	2460 x 2158/2258	1660	895	125
	1800 x 2000/2100	2455 x 2158/2258	1860	1025	125
	2000 x 2000/2100	2320 x 2158/2258	2060	1150	125
1500	1200 x 2000/2100	2300 x 2158/2258	1260	680	125
	1400 x 2000/2100	2520 x 2158/2258	1460	770	125
	1600 x 2000/2100	2730 x 2158/2258	1660	910	125
	1800 x 2000/2100	2835 x 2158/2258	1860	1000	125
	2000 x 2000/2100	2875 x 2158/2258	2060	1130	125
1700	1200 x 2000/2100	2330 x 2158/2258	1260	640	125
	1400 x 2000/2100	2660 x 2158/2258	1460	780	125
	1600 x 2000/2100	2885 x 2158/2258	1660	870	125
	1800 x 2000/2100	3065 x 2158/2258	1860	965	125
	2000 x 2000/2100	3225 x 2158/2258	2060	1100	125
1800	1200 x 2000/2100	2355 x 2158/2258	1260	640	125
	1400 x 2000/2100	2685 x 2158/2258	1460	780	125
	1600 x 2000/2100	2930 x 2158/2258	1660	875	125
	1800 x 2000/2100	3135 x 2158/2258	1860	970	125
	2000 x 2000/2100	3325 x 2158/2258	2060	1105	125
2000	1200 x 2000/2100	2385 x 2158/2258	1260	645	125
	1400 x 2000/2100	2760 x 2158/2258	1460	785	125
	1600 x 2000/2100	3030 x 2158/2258	1660	880	125
	1800 x 2000/2100	3275 x 2158/2258	1860	975	125
	2000 x 2000/2100	3480 x 2158/2258	2060	1070	125

## NOTES

When fitting flush pull handles we recommend the stop be regulated so the door protrudes from the pocket to avoid risk to fingers.  
Should the door be set to enter the pocket completely we do not accept any liability.

Plasterboard not supplied.

Sliding system, door jambs and final architraves all supplied.  
Please specify at time of order if doors should be cut for flush pulls. If non is specified then the doors will be cut for these.

dimensions are given in mm.